

MAXIMUM PCB SIZE

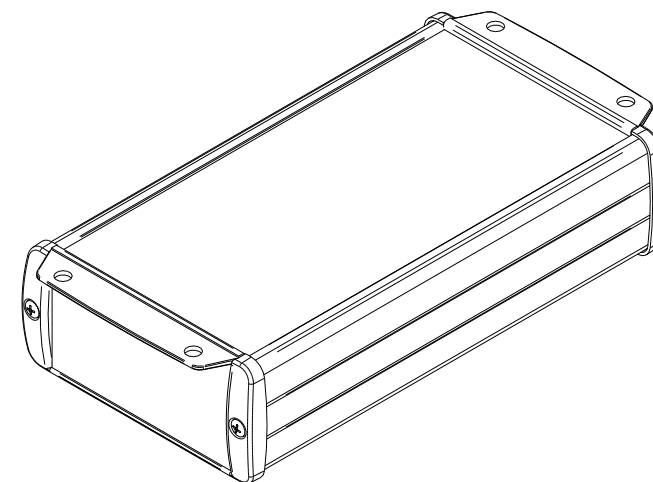
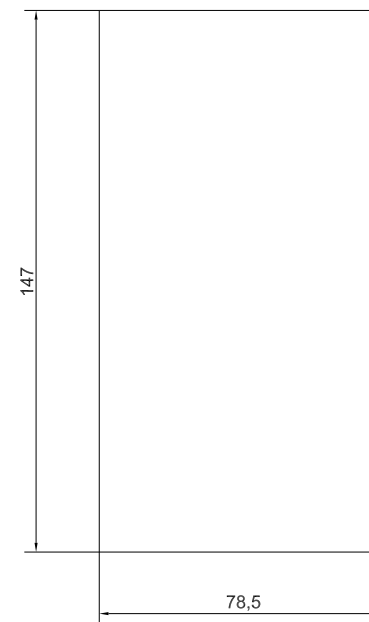

	Denomination	Part. Number	
	Assembly TEKAM-23E Subject to technical modification without prior notice. Tipographical and other errors do not justify any claim for damages. All dimensions should be verified using an actual moulded part.	TEKAM-23E	
	Rev. Index	Date	Scale
		24/04/2007	1:1 Format design A2

This document contains proprietary information of TEKO S.p.a. and is tendered subject to the conditions that the information be retained in confidence not be reproduced or copied and not be used or incorporated in any product.