

B-B

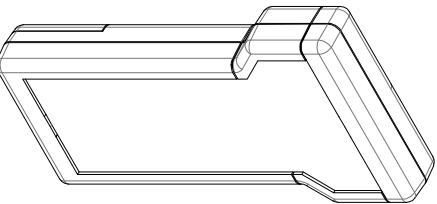
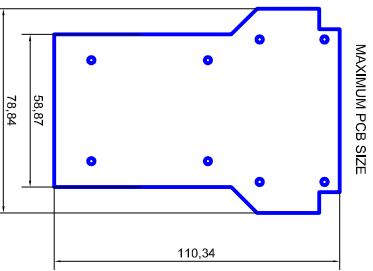
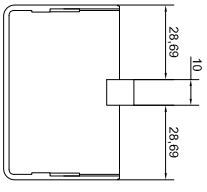
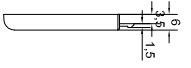
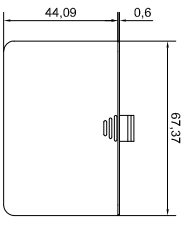
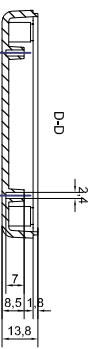
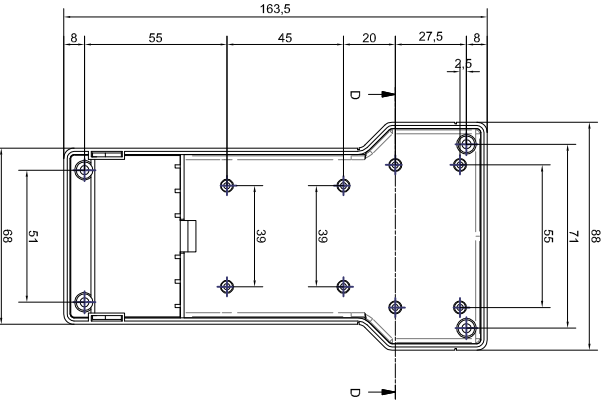
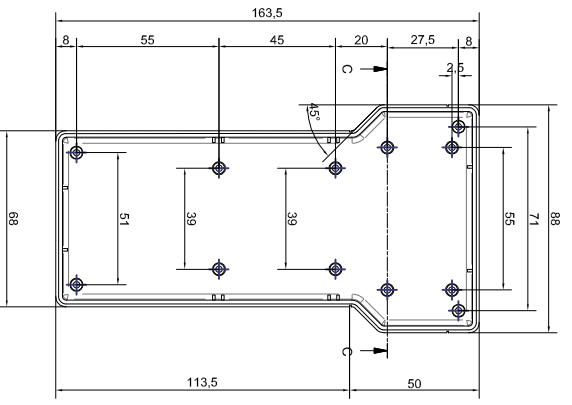
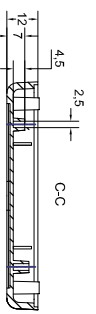
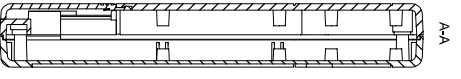
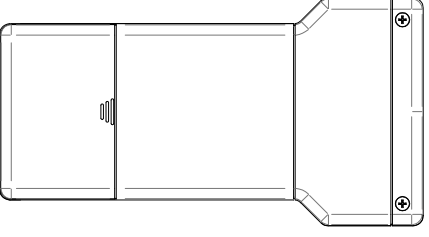
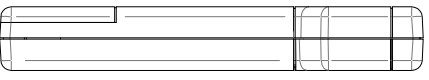
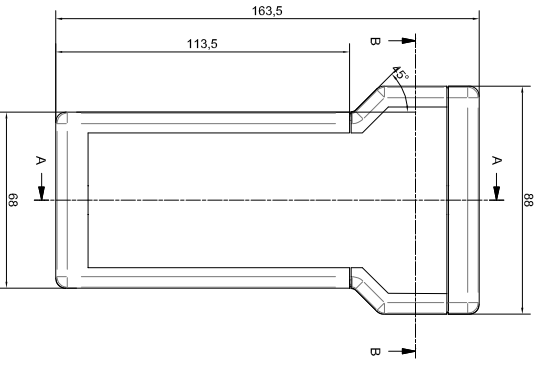
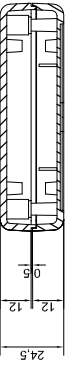

<p>TEKO ENCLOSURES</p>	<p>Subject to technical modification without prior notice. The appearance and dimensions are subject to change without notice. All dimensions should be verified using an actual modelled part. The enclosure is not intended for use in hazardous environments. The enclosure is not intended for use in hazardous environments. The enclosure is not intended for use in hazardous environments.</p>	<p>Product Name</p> <p>Assembly TBT-B</p>	<p>Product Name</p> <p>TBT-B</p>
	<p>Scale</p> <p>1:1</p>	<p>Scale</p> <p>1:1</p>	
<p>Date</p> <p>31/01/2017</p>	<p>Date</p> <p>A1</p>	<p>Product Name</p> <p>TBT-B</p>	<p>Product Name</p> <p>TBT-B</p>